



VOLVO XC40





A VERSATILE SPACE

Everything starts with people at Volvo Cars – it's why we look, listen, and design cars around their needs. And it's why the XC40 is full of practical, versatile features that help you carry what you want as easily as possible. Load and unload your car with ease thanks to a large cargo area that can be accessed by a hands-free power-operated tailgate. If you need to carry bulky or unusually tall items then you can take advantage of the foldable, removable load floor. And if you need even more space, fold the rear seat backrests flat at the touch of a button.



Valuable items can be stored securely out of sight under the locking load floor. And, to make the load area as versatile as possible, the folding floor can be placed in multiple positions. There are also four load-securing eyelets to keep delicate items safe and to protect the car's occupants, plus two bag hooks that ensure your shopping doesn't move around or spill in transit. Whatever type of load you need to carry – large or small – your XC40 helps make it effortless.



Go hands-free

When your hands are full, the power-operated tailgate on the XC40 makes life easy – it means you only need to move your foot under the rear bumper to open or close it automatically.



The right fit

The XC40 helps you fit your life into your car. The load compartment is one of the largest in the class, with a regular shape that helps you make the most of the space. And the folding load floor helps you adapt it to whatever you're carrying.



STAND TALL

High ground clearance gives the XC40 a powerful stance and excellent visibility. Large wheels and tyres cope effortlessly with any road. This is the SUV that allows you to rise above it all.

ALWAYS READY

Large alloy wheels and a wide body give the XC40 a strong presence. This is an SUV that is ready for anything.

MAKE A BOLD IMPRESSION

Make a statement with a choice of contemporary colours. And, depending on trim level, the roof and door mirror housings can be specified in a contrasting colour for an even bolder look.





STRENGTH OF CHARACTER

The XC40 expresses toughness, and is unmistakably a Volvo, through features such as its proud grille, T-shaped light signatures and sculpted front bumper with skid plate.

LIGHTING WITH DISTINCTION

See and be seen, day or night, with LED headlights that feature Volvo's unique T-shaped light signature. They automatically adjust the beam height, and switch between dipped and full beam, to provide the best view and avoid dazzling other road users. The optional high-level LED headlights include active bending lights that turn with the steering (by up to 30°), to provide a better view through corners.



SPECIALLY DESIGNED ALLOY WHEELS

A selection of alloy wheels helps you to create your perfect XC40. Each one has a bold, dynamic design, as well as the attention to detail and high quality finish you expect from a Volvo.





“Sensus is our way of enabling you to communicate instinctively with your car, and keep you connected with your digital world.”

YOU'RE IN CONTROL, NATURALLY.

SENSUS

Nothing rounds off a drive in your car better than luxuriating in the rich sound of your favourite piece of music. And our two sound systems – Premium Sound by Harman / Kardon and High Performance Sound – turn any drive into a momentous experience.

Thanks to Sensus Connect, which is standard, you can stream your favourite tunes from your device to your car via Bluetooth®. You can also use Bluetooth®, WiFi tethering or the new P-sim (personal sim card slot) to connect your Volvo XC40 to the internet. You can then browse the web and access a variety of internet radio and media apps.

With Sensus Navigation, you can view your route on the centre display with touch screen functionality. And with smartphone integration you can use the centre display to access your smartphone as well. And if you would like to connect devices physically, USB-ports are provided as well.

“Relax and let your Volvo do the hard work for you.”

“Our Drive-E powertrains give you an exhilarating driving experience with smooth, instant response and a reduced environmental impact.”

COMMITTED TO SAFETY.

SUSTAINABLE DRIVING IS EXCITING.

INTELLISAFE

Since the birth of Volvo Cars in 1927, keeping you safe has been part of our DNA. We have pioneered safety advances and invented life-saving technologies, such as the three-point safety belt. We have also equipped all of our cars with safety cages and laminated windscreens since 1944. In 1976, we developed the catalytic converter and the lambda sond, a sensor that monitors exhaust gas, reducing emissions and boosting performance as well as economy.

Today, we are building cars that actively scan the area around you, looking out for the unexpected. Volvo pioneered City Safety, a low-speed collision avoidance technology that helps prevent collisions even up to highway speeds. We were the world's first car manufacturer to include this feature as standard equipment in all new models.

We also developed Pedestrian Detection, a system that detects pedestrians and brakes the car when necessary, and we will not stop there. Cyclist Detection and Large Animal Detection are recent additions to the system.

Tracker Connect provides access to roadside assistance and emergency support at the touch of a button. In the future, our aim is to design cars that will prevent collisions with other road users altogether.

DRIVE-E

At the heart of every Volvo car we make is our approach to sustainable driving and innovative thinking. We offer a range of technologies that give you greater efficiency and lower running costs.

Our Drive-E powertrains combine the low fuel consumption and emissions of a four cylinder engine with the performance of a six or eight cylinder engine. The result is a smooth, powerful drive, with fewer stops at the pumps. We also offer an interior Air Quality System that checks incoming air for pollutants and closes the vents when necessary – we call this CleanZone. An active carbon filter

helps protect you from harmful gases and unpleasant odors, so you can breathe happy and healthy.

At Volvo Cars, we always strive to make our manufacturing process sustainable. All of the electricity for our factories in Sweden and Belgium comes from clean hydro-electric or wind power. Environmentally-aware mobility is central to our philosophy of intelligent, thoughtful luxury.



VOLVO XC40 FEATURE EXPLANATION

CITY SAFETY WITH FRONT COLLISION WARNING AND FULL AUTOBRAKE

Included as standard in your XC40 is City Safety, which senses potential collisions, even when it is dark, and can activate the brakes automatically should you not react in time. City Safety provides three levels of intervention; warning, brake support and full automatic braking and uses a combination of instruments and sensors to constantly monitor surrounding conditions.

PEDESTRIAN, CYCLIST AND LARGE ANIMAL DETECTION

The groundbreaking Pedestrian, Cyclist and Large Animal Detection technology detects and automatically brakes the vehicle in the event of a pedestrian, cyclist or large animal (such as cattle) stepping / swerving / jumping out in front of the car. The advanced sensor system scans the area ahead and will prompt you to act with a flashing warning light, along with an audible alarm. If you do not react to the warning, and a collision is imminent, the car immediately brakes with full braking force.

REAR COLLISION WARNING WITH BRAKING AT STANDSTILL

Rearward facing radar detects if a rear impact is imminent, and safety belts are tightened in advance in order to protect the occupants. Lights also start flashing to warn the driver behind and brakes are activated to help reduce the impact movement.

LANE KEEPING AID

Lane Keeping Aid is a standard-fitted system that helps the driver to keep the car in its lane by gently steering the car back if it is about to cross a lane marking if the car senses that the driver is not driving actively, or for example, not using their indicators. If the supplied steering intervention is insufficient the driver is alerted by vibrations in the steering wheel. The system is active between 65-200 km/h.

ROAD SIGN INFORMATION SYSTEM

The XC40 can also help you stay informed by displaying real-world road sign information within your instrument display. This function also has the ability to warn the driver should the vehicle exceed the current road speed limit.

PILOT ASSIST

Optionally available, is Volvo's next generation of Pilot Assist. The Adaptive Cruise Control feature maintains the desired set vehicle speed but utilises radar to monitor the vehicle in front and automatically slows down or speeds up as necessary. In an evolution of this, Pilot Assist also takes care of the steering (up to 130 km/h and when lane markings are clearly visible) by continually monitoring the area in front of the vehicle, making the necessary steering, accelerator and brake inputs as required to keep to the desired speed, distance and within the lane markings.

BLIND SPOT INFORMATION SYSTEM WITH CROSS TRAFFIC ALERT

The Blind Spot Information System uses radar to alert the driver to vehicles within the mirror blind spots, on either side of the vehicle. Cross Traffic Alert uses radar to provide information to the driver about vehicles approaching from the side - for example when reversing out of a parking space. New in the XC40, Cross Traffic Alert now also includes braking support, which allows the car to brake on its own if an impact from either side is imminent.

PARK ASSIST PILOT

This function allows the car to take over steering control in difficult parallel or perpendicular parking spots. The driver is prompted to control the throttle, braking and gear inputs. The "park out" function also assists in exiting tighter spots.

VISUAL PARK ASSIST 360° CAMERAS

During low speed manoeuvres, the Visual Park Assist 360° Cameras provide the driver with additional information relating to the car's surroundings. A birds-eye view of the car is provided via four hidden cameras, digitally stitched together to create a seamless image on the centre screen.

RUN-OFF ROAD MITIGATION AND RUN-OFF ROAD PROTECTION

Run-off road accidents are amongst the largest cause of single vehicle accidents. To combat this, Volvo Cars has developed two support systems aimed at helping to avoid a run-off road accident from taking place, or protecting the car's occupants in the case of an unavoidable road departure. The Run-off Road Mitigation function is designed to help prevent unintentional road departures at vehicle speeds between 65-140 km/h. Run-off Road Protection focuses on accidental road departure. Using input from the car's advanced sensor system, the technology is able to detect a run off road scenario.

DRIVER ALERT CONTROL

Distraction, lack of concentration, and falling asleep are major reasons for accidents. In 2007 Volvo Cars introduced a world-first technology to combat this danger. Driver Alert Control keeps track of the car's path in relation to lane markings on either side, by means of the camera in the windscreen. If the system detects that the car is being driven in an erratic manner the driver gets an alert in the form of an audible signal as well as a text message and a coffee cup symbol in the driver display, that indicate it is time to take a break. With Sensus Navigation, the driver also gets guidance to the next available place to take the break.

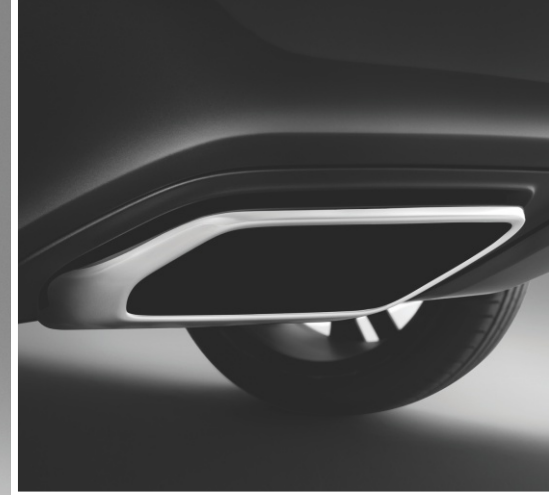

CHOICES THAT MAKE YOUR VOLVO AS UNIQUE AS YOU ARE

Choose the Volvo XC40 R-DESIGN and the XC40 receives a first class attitude adjustment - inside and out. Boldly provocative yet tastefully reserved, the exclusive R-DESIGN styling elements and sports chassis express a definitive passion for performance. From its aggressive nose with larger intakes to the rear diffuser with dual integrated exhaust tailpipes, the Volvo XC40 R-DESIGN exudes confidence at every turn.



R-DESIGN upholstery

Settle back in unique off black Nubuck perforated leather sports seats.

R-DESIGN decor inlay

The dashboard and door panel inlays convey a sporty, contemporary feel.

Sports gear knob

A sporty gear knob with perforated leather, gives a performance ready look and feel.

Sports pedals

Enhance the driving experience with these tough, ridged sports pedals.

Sports steering wheel

Every R-DESIGN model features an exclusive sports steering wheel with embossed logo.

Sports floor mats

Look down and you will see exclusive sports floor mats that set the stage, front and back.

VOLVO ON CALL

The key to your digital world.

ALWAYS THERE WHEN YOU NEED IT

WARMS UP THE CAR *(or cools it down)*

KNOWS THE BEST RESTAURANTS *(and shows you the way)*

CALLS ROADSIDE ASSISTANCE *(and tells them where you are)*

With Volvo On Call, your car becomes more than just a means of travel – it is your personal assistant. It can tell you about the best coffee in town and send the destination to your car's navigation system. It knows when you have got appointments, where they are and how to get there. You can use it to make your car ready for the drive to the office, or the drive home, by remotely

cooling or heating the cabin. It helps to keep you safe, automatically contacting the emergency services if you are involved in an accident and telling them where you are. Volvo On Call keeps you connected to the things you need. It is always on. Always with you. Always there.



EVERYTHING IN ONE PLACE

*One app gives you control over your car's functions
and access to a world of convenient services.*

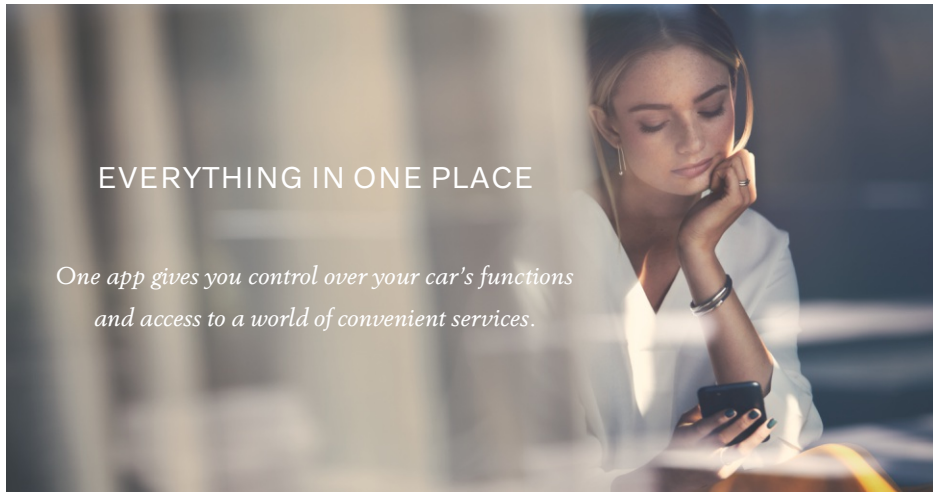

WARM WHEN IT'S COLD, COOL WHEN IT'S HOT

With remote climate control you should never need to wear a coat in the car again.

In Volvo cars from Model Year 2020, Volvo On Call can start the engine remotely so you can heat or cool the cabin. It is as easy as sending a text. Just select how long you want the engine to run for, confirm with your finger print or enter your Volvo ID password and the car will start.

Cars started using remote start cannot be driven – the engine has to be started with the key first.

Own a Volvo plug-in hybrid? Then you can use the car's system to heat and cool the car without needing to start the engine. We call it pre-conditioning. Tell the app when you want the car to be at the desired temperature and it will take care of starting the climate control at the right time.

YOUR DAY MADE EASIER WITH VOLVO ON CALL

From saving you time in the morning to helping you relax on the way home, Volvo On Call can be an indispensable part of your daily routine.

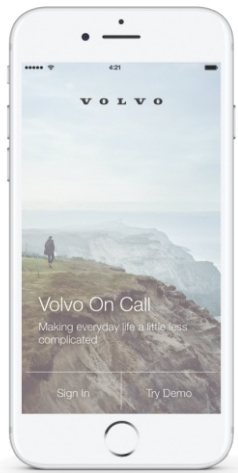

THE PERFECT START

When you get into the car in the morning it is warm and defrosted, thanks to the Volvo On Call app's ability to precondition the cabin. En route, you press the On Call button in the car and ask the operator to send your destination to the car's navigation system, so you do not have to manually enter it.

07.30



FIND YOUR CAR

You have forgotten where you parked, so you use the car locator map to find the street and then use the flash lights function to pinpoint the car.

12.00



FIND A RESTAURANT

You head for home, not feeling for making dinner. The Volvo On Call operator knows where to go and sends the destination to your car's navigation system within seconds.

17.45



READY FOR A NEW DAY

A notification reminds you that you have a meeting in the morning. You send the location to the Sensus Navigation system and set the timer to precondition the cabin before you leave.

FINDS AND LOCKS YOUR CAR



If you forget to lock your car, the app will tell you and you can lock it remotely. You can also check the door lock status and unlock it too, making it possible to give anyone access to the car's interior. And you can do all of this wherever you are in the world.

Forgotten where you parked your Volvo? The built-in map in Volvo On Call will show you where your car is, give you directions to it and you can flash its lights from the app when you get near it.



With Volvo On Call aboard, you can experience the relief of having instant knowledge and personal support with the touch of a button. For example, if you are driving in heavy traffic looking for a nice restaurant, just press the On Call button in the car to get in touch with a Volvo On Call operator. Tell the operator what you are looking for, and in seconds your Sensus navigation system starts to guide you to the location.

Maybe you want to call somebody but do not know the number? Press the button, and the Volvo On Call operator will send you the number or connect you instantly.

In fact, Volvo On Call is like having a personal assistant by your side, 24/7.

CONNECTED TO THE WORLD

The Volvo On Call modem maintains a strong internet connection, giving you in-car wifi and hassle-free use of all in-car-apps wherever you go.



You can always connect your Volvo to the internet and access the in-car apps by creating a connection via your own mobile phone. With Volvo On Call, you can enjoy an even stronger, more reliable connection and the possibility of creating an in-car wifi hotspot. This is made possible by the Volvo On Call car modem and an additional SIM-card.

A reliable, strong signal

Your 4G* signal is strong and consistent because you are using the Volvo On Call roof aerial, making it easy and quick to use the internet. Where a phone would struggle with finding a signal in the car, the system in your Volvo can often work much better.

**Network dependant.*

Saves battery life

Using the Volvo On Call modem in your car to connect to the internet, means you do not drain the batteries of your portable devices, so they are ready to use when you really need them.

Streaming on the move

The strong signal means streaming music and films is quick and reliable, helping to prevent significant buffering or loss of data.

Wifi hotspot inside the car

Volvo On Call turns your car into a wifi hotspot, with the capacity to connect up to eight devices. So everyone in the car gets to use wifi, using their own device.

"HELLO. THIS IS THE VOLVO ON CALL OPERATOR. WE HAVE FOUND YOUR LOCATION AND WE ARE SENDING HELP."

In the case of an emergency, Volvo On Call is there to help make it better – 24 hours a day, seven days a week, 365 days a year.

With trained operators always on call, if something goes wrong you will get help straight away. Emergency assistance and access to roadside assistance are included in Volvo On Call, so you will get exactly the help you need – whether you were involved in an accident or a tyre punctured.

The GPS capability of Volvo On Call means the operators at the service centre can pinpoint your exact location. Even if you do not know where you are, the emergency services will.



Emergency services

In an emergency, press the SOS button and you are instantly connected to the Volvo On Call operator. They will send help (they will know where you are without you having to tell them) and stay with you until help arrives. It is like having a guardian angel sit next to you in the passenger seat.

Roadside assistance

Your on-demand breakdown service, ready to send assistance when you need help. Press the On Call button in your car or use the app to contact the service centre. An operator will find your position and send help.

Crash notification

If an airbag goes off or the safety belt pre-tensioners are activated – both of which will only happen if your car is involved in an accident – the car will automatically alert a Volvo On Call operator. They will then call you to find out what has happened. If they cannot reach you by phone, they will automatically send the emergency services to your location.

GETTING STARTED

Getting started with Volvo On Call is very straightforward and the app is simple to use.

Create and register a Volvo ID

You have to create a Volvo ID which you then register to your car in order to be able to access all connected services. This article describes how to create and register a Volvo ID to your car.

Create a personal Volvo ID

To create a Volvo ID, you must register an e-mail address and follow the instructions in the confirmation message sent to you. You can create a Volvo ID in the following ways:

- Via your Volvo
- Via the Volvo On Call app.
- Via www.volvocars.com/za/support
- Via your Volvo dealer who can help you to create a Volvo ID on request.

When you have created a Volvo ID you need to connect the Volvo On Call app to your car. Read more on www.volvocars.com/za/support

Can I try it out?

Yes – and you do not even need to own a Volvo. You can download the app for free and try it in demo mode, which gives you access to most of the app's functions.

What does it cost?

Volvo on Call is included in the new vehicle price covering all of its functions. Stolen vehicle recovery requires a separate subscription @ R199 p/month through Tracker. Costs related to the additional SIM-card are not included. New cars come with a five year subscription, after which it can be extended for a small fee. The cost varies according to the country you are in, so talk to your Volvo dealer to find out more.

How do I get Volvo On Call?

When you order your new Volvo, access to Volvo On Call comes as a standard feature from Model Year 2020. While you are waiting for the car to be delivered, download the app and try the demo version. When you collect your new car, the dealer activates Volvo On Call and you get a Volvo On Call PIN. This gives you access to the app and will control some of the app's services.

What devices can I use it on?

Volvo On Call is available for your smartphone, smart-watch, tablet and desktop.

Please note: Using the Volvo On Call app requires your car to be factory-equipped with Volvo On Call, model year 2020 and later. Depending on the model of your Volvo, there may be variations of the features available. Some of the functions and services are depending on mobile phone coverage and internet access, and may not be available in some markets.

** For more information and detailed compatibility please visit support.volvocars.com*

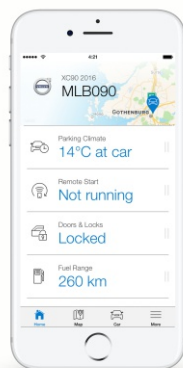

HOME

This is the starting page for everything you can do with Volvo On Call. From here you can find shortcuts to control the car's cabin temperature, start it remotely, lock and unlock it or find details of your recent trips.

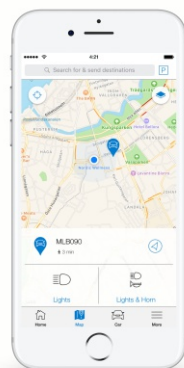

MAP

Volvo On Call's map lets you know where your car is, tells you where you are and allows you to search for destinations that you can send to the car's navigation. And, if you cannot find your car in a car park, it can flash the lights and sound the horn. You can even use it to keep an eye on traffic conditions.

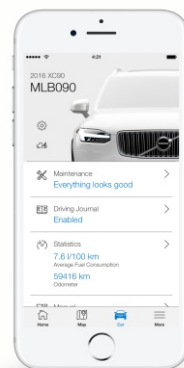

CAR

The Car screen keeps you up to date with your car's vital statistics and allows you to book a service. It is also where you can remotely check the status of items such as tyre pressure and washer and brake fluid levels. You can also keep a detailed record of your journeys using the Driving Journal.

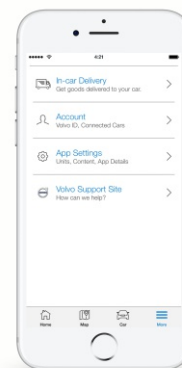

MORE

On this screen, you can adjust the app's settings and if you need extra help, you can connect to the Volvo Support Site from here, too.

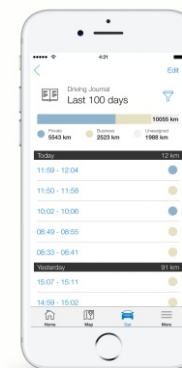

DRIVING JOURNAL

When this feature is enabled, each journey is automatically logged for 100 days, with data on where you have been, how long it took and how much fuel you used. The driving journal can be exported from the app to your email.

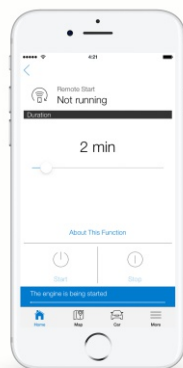

REMOTE START

Volvo On Call can start your engine remotely*, so you can cool down or warm up the cabin. Just choose how long you want the engine to run for and enter your Volvo ID password (it also works with Touch ID on Apple iPhone®).

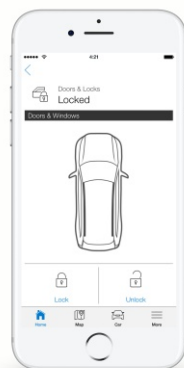

DOORS AND LOCKS

The Volvo On Call app will check on the lock status of your car and, if any of the doors are unlocked, can lock them remotely. You can also unlock the car – no matter where you are – if you need to give access to a family member, for example.

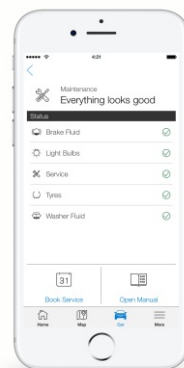

MAINTENANCE

Monitor the health of your car. As long as all temperatures, pressures and fluids are within operating range, and the next service is not overdue, the app will display the message 'everything looks good'.

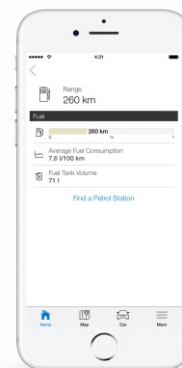

FUEL RANGE

Shows you how far you can travel on the remaining fuel in the tank, and your average fuel consumption.

** Automatic transmissions only.*

COLOUR YOUR VOLVO. When it comes to the appearance of your Volvo, the choice of exterior colour and wheels are probably your most important design decisions. For more exterior styling options and to build your new Volvo online, please visit www.volvocars.com/za and go to Build your Volvo.



019 Black Stone
solid (i), (ii), (iii)



614 Ice White
solid (i)



707 Crystal White
pearl metallic (ii), (iii)



717 Onyx Black
metallic (i), (ii), (iii)



720 Bursting Blue
metallic (iii)

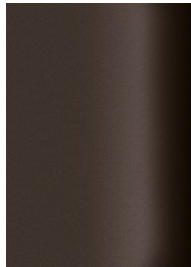

722 Maple Brown
metallic (ii)



723 Denim Blue
metallic (ii)

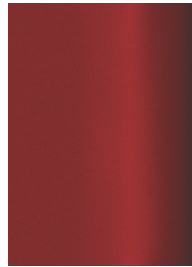

725 Fusion Red
metallic (i), (iii)



727 Pebble Grey
metallic (i)

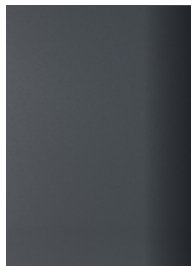

728 Thunder Grey
metallic (i), (ii), (iii)



729 Glacier Silver
metallic (i), (ii), (iii)

(i) Available on Momentum (ii) Available on Inscription (iii) Available on R-Design

Please note: It is not possible to reproduce exact original shades in printed matter. Please ask your dealer to show you samples.

CLEAN COLOURS. To reduce usage of environmentally hazardous solvents all Volvo exterior colours are water-based. What is more, our painting facilities are among the cleanest in the world.





EXTERIOR DESIGN. XC40 Alloy wheels.

DC: Diamond Cut



18" 5-Spoke silver
(Momentum)



18" 6-Spoke black, DC
(Inscription)



19" 5-Spoke black / white
(Momentum)



19" 5-Spoke black, DC



19" 5-Double spoke,
matt black, DC
(R-DESIGN)



19" 5-Double spoke,
black, DC (Inscription)



20" 5-Spoke black, DC



20" 5-Double spoke,
matt black, DC
(R-DESIGN)



21" 5-Triple open spoke,
black, DC
(Accessory wheel)

BESPOKE TAILORING FROM VOLVO. The finest fabrics, superb stitching and exacting attention to detail – whichever interior you choose for your Volvo XC40, you will be surrounded by luxury. How will you tailor yours?

NB It is not possible to reproduce exact original shades in printed matter.

Code	Description	Interior colour	Upholstery colour	Upper dashboard	Door panel, lower dashboard & upper tunnel console	Base and inlay carpets	Door panel inserts	Headliner colour
Textile / T-Tec								
R300	Textile / T-Tec	Charcoal	Charcoal	Charcoal	Charcoal	Charcoal	Charcoal	Blond
U470	Textile / T-Tec	Charcoal/Blond	Blond	Charcoal	Blond	Charcoal	Blond	Blond
Standard leather								
RD00	Leather	Charcoal	Charcoal	Charcoal	Charcoal	Charcoal	Charcoal	Blond
RD20	Leather	Charcoal	Amber	Charcoal	Charcoal	Charcoal	Charcoal	Charcoal
RD90	Leather	Charcoal	Cranberry	Charcoal	Charcoal	Charcoal	Charcoal	Charcoal
UD70	Leather	Charcoal	Blond	Charcoal	Blond	Charcoal	Blond	Blond
R-Design Upholstery								
RB00	Nubuck / leather	Charcoal	Charcoal	Charcoal	Charcoal	Charcoal	Charcoal	Charcoal
*RD00	Leather	Charcoal	Charcoal	Charcoal	Charcoal	Charcoal	Charcoal	Charcoal

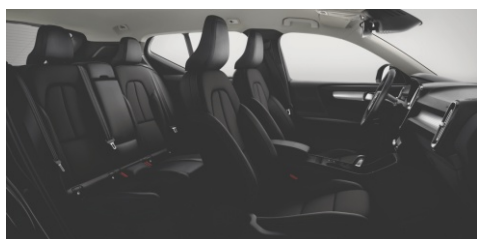

R300



RD00

*Also available on R-DESIGN with charcoal headliner



RD20



RB00 (R-DESIGN)



U470



RD90



UD70



INTERIOR DETAILS. A selection of premium materials to complement your interior upholstery.



Leather steering wheel, Charcoal



R-DESIGN Sport leather steering wheel

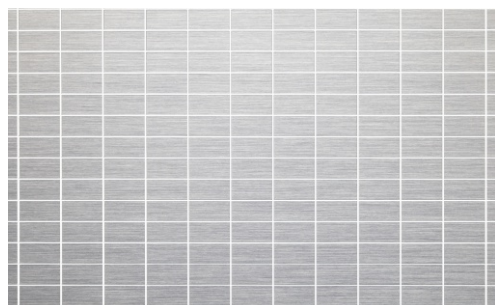

Aluminium decor inlay (Momentum)

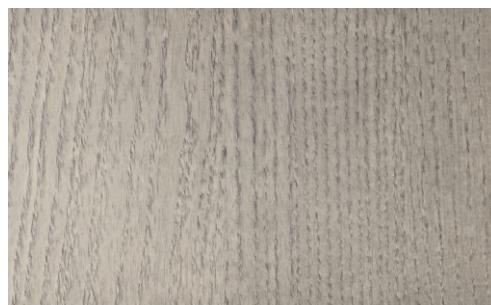

Driftwood decor inlay (Inscription)

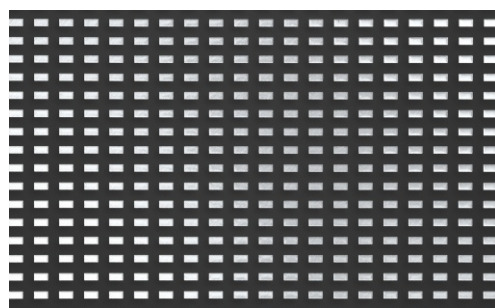

Aluminium decor inlay (R-Design)





YOUR OWN XC40 IS WITHIN REACH

Introducing the new Volvo XC40 – the compact SUV that is big on innovation. With expressive design, ingenious storage and smart technology, it is built for city life.

We approached the XC40 with a clear aim: to create a car that will make your life easier.

The result is a car with a commanding view of the road as well as an agile drive. A car with clever storage for all your belongings.

The XC40 could only come from Sweden, a country of innovation, creativity and progressiveness. A place where we do things differently.

XC40 MOMENTUM

Everything about the XC40 Momentum is self-assured and confident. It is genuinely urban with a Swedish twist. Strong, contemporary style, available in contrasting combinations.

Variants:

Diesel

D4 Geartronic AWD

Petrol

T3 Manual FWD

T3 Geartronic FWD

T5 Geartronic AWD

XC40 INSCRIPTION

A fresh approach to luxury. Elegant details and a carefully crafted interior - Inscription is the epitome of modern Scandinavian design.

Variants:

Diesel

D4 Geartronic AWD

Petrol

T3 Manual FWD

T3 Geartronic FWD

T5 Geartronic AWD

XC40 *R*DESIGN

Inspired by the art of driving. Experience R-Design – our most powerful expression, characterised by bold contrasts and a confident presence.

Variants:

Diesel

D4 Geartronic AWD

Petrol

T3 Manual FWD

T3 Geartronic FWD

T5 Geartronic AWD





THE RIGHT EQUIPMENT. It is essential that your Volvo comes equipped with everything you need. Below you will find standard equipment for each model variant, plus optional equipment to personalise your Volvo XC40. And as you would expect, there is an array of industry-leading, cutting edge safety innovations.

STANDARD EQUIPMENT – SAFETY AND SECURITY	Momentum	Inscription	REDESIGN
City Safety (includes pedestrian, cyclist and large animal detection and front collision warning with full auto brake)	•	•	•
Oncoming lane mitigation	•	•	•
Run-off road mitigation	•	•	•
(DAC) Driver Alert Control with (LKA) Lane Keeping Aid	•	•	•
(RSI) Road Sign Information	•	•	•
(IDIS) Intelligent Driver Information System	•	•	•
Collision Mitigation Support, front	•	•	•
Emergency Brake Assist	•	•	•
Safety cage with ultra high strength steel	•	•	•
Seatbelt reminders, all seats	•	•	•
Pyrotechnical pre-tensioners (all seats)	•	•	•
Dual stage driver and passenger airbags	•	•	•
Knee airbag, driver side	•	•	•
Passenger airbag cut-off switch	•	•	•
(SIPS) Side Impact Protection System	•	•	•
SIPS airbags (front seats)	•	•	•
Inflatable curtains - full length	•	•	•
Whiplash protection system (front seats)	•	•	•
Vehicle deceleration control (includes anti-lock brake system, electronic brake force distribution and emergency brake assist)	•	•	•
Stability and traction control (includes spin control, engine drag control and corner traction control)	•	•	•
ISOFIX attachments (outer rear seats)	•	•	•
Anti-theft alarm including immobiliser, volume sensor and level sensor	•	•	•
Integrated remote control central locking and auto open / close power windows and sunroof	•	•	•
Key remote control	•	•	•
Two step door unlocking	•	•	•
Private locking for luggage area and glove box	•	•	•
Central lock switch with diode in front doors	•	•	•
Volvo on Call	•	•	•
Telematics unit with P-sim slot	•	•	•
Visible VIN plate	•	•	•
Home safe and approach lighting	•	•	•
LED daytime running lights	•	•	•
Warning triangle	•	•	•
Laminated side windows with UV protection (Llumar film)	•	•	•
First aid kit	•	•	•

STANDARD EQUIPMENT – EXTERIOR	Momentum	Inscription	RDESIGN
Standard front grille	•		
Inscription grille		•	
Bright integrated roof rails	•	•	
Glossy black integrated roof rails			•
Standard mesh front	•		
Inscription mesh with chrome strips		•	
Standard window trim	•		
Bright window trim - lower part		•	
Hidden exhaust tail pipes	•		
Dual integrated exhaust tail pipes		•	•
Colour coordinated side mirror covers	•	•	
Silver skid plates, front and rear	•	•	
Inscription C-pillar moulding		•	
Electrically heated and retractable side mirrors	•	•	•
LED headlights with active high beam	•	•	•
Fog lights in front spoiler		•	•
Adaptive brake lights including high level LED brake light and hazard warning	•	•	•
Rear park assist	•	•	•
18" 5-Spoke silver alloy wheels	•		
18" 6-Spoke black diamond cut alloy wheels		•	
19" 5-Spoke matt black diamond cut alloy wheels			•
Dynamic chassis	•	•	
Tempa spare wheel and jack kit	•	•	•
Capless fuel filler system	•	•	•
RDESIGN Solid black exterior roof colour			•
RDESIGN C-pillar moulding			•
RDESIGN High gloss black mesh front grille			•
RDESIGN Glossy black front skid plate			•
RDESIGN Glossy black window trim, lower part			•
RDESIGN Metal scuff plate, cargo opening			•
RDESIGN Glossy black side mirror covers			•
RDESIGN Sports chassis			•

STANDARD EQUIPMENT – INTERIOR	Momentum	Inscription	RDESIGN
Textile / T-Tec upholstery - comfort seats	•		
Leather upholstery - comfort seats		•	
Storage box under driver seat	•	•	•
Aluminium decor inlay	•		
Driftwood decor inlay		•	
12,3 Inch digital instrument cluster	•	•	•
Trip computer	•	•	•
Cruise control	•	•	•
Mechanical driver seat with height / length and tilt adjustment	•		
Power driver seat with memory for seat and side mirrors		•	•





STANDARD EQUIPMENT – INTERIOR CONTINUED

	Momentum	Inscription	RDESIGN
Mechanical passenger seat with height and length adjustment	•		
Power adjustable passenger seat		•	•
Mechanical adjusted cushion extension, driver and passenger side		•	•
4-Way power adjustable lumbar support	•	•	•
Versatile split folding rear seat (60 / 40)	•	•	•
Ski hatch in rear seat backrest	•	•	•
Front and rear armrests with storage and cup holders	•	•	•
Interior illumination - mid level	•		
Interior illumination - high level		•	•
Windscreen parking ticket holder	•	•	•
Illuminated vanity mirrors in sunvisor LH / RH side	•	•	•
3-Spoke leather steering wheel with decor inlay	•	•	
Leather gear lever knob with chrome decor inlay	•		
Crystal gear lever knob (automatic only)		•	
Standard pedals	•	•	
Cigarette lighter / ashtray front	•	•	•
Auto dimming interior mirror	•	•	•
Floor carpets	•	•	•
Volvo branded front tread plates, plastic	•		
Metal front tread plates, Inscription		•	
Drive modes and power steering settings	•	•	•
Hill Start Assist	•	•	•
Lockable glove box compartment with illumination and carry hook	•	•	•
Rain sensor	•	•	•
Front and rear power windows – fully automatic	•	•	•
Luggage compartment illumination	•	•	•
2-Zone electronic climate control with cooled glove box	•	•	•
CleanZone interior (air quality system with pre-ventilation at unlocking)	•	•	•
High Performance Sound system with Bluetooth® (2 x USB front and 1 x USB rear)	•	•	•
Remote control buttons on steering wheel	•	•	•
Smartphone integration (Apple CarPlay and Android Auto)		•	•
Inductive charging for smartphones, front tunnel		•	•
Navigation - Pro	•	•	•
Road Sign Information System	•	•	•
RDESIGN Suede / Nubuck sport leather upholstery			•
RDESIGN Aluminium decor inlay			•
RDESIGN Leather steering wheel with decor inlay, 3-spoke			•
RDESIGN Gearshift paddles			•
RDESIGN Leather gear knob			•
RDESIGN Pedals			•
RDESIGN Carpet kit			•
RDESIGN Key remote control, leather clad			•
RDESIGN Charcoal headliner			•
RDESIGN Front tread plates, metal			•

*** OPTIONAL EQUIPMENT – SAFETY AND SECURITY**

	Momentum	Inscription	RDESIGN
IntelliSafe assist with Adaptive Cruise Control, Pilot Assist and Lane Keeping Aid	o	o	o
(BLIS) Blind Spot Information System with (CTA) Cross Traffic Alert and collision warning with mitigation support, rear	o	o	o
Rear park assist camera	o	o	o
Park Assist Pilot with park assist front and rear and PAS-triggered braking	o	o	o
Park assist front and rear	o	o	o
Visual park assist with front "Fisheye" view (360° camera) (iii)	o	o	o
Tinted windows, rear side doors and rear window	o	o	o

*** OPTIONAL EQUIPMENT – INTERIOR**

	Momentum	Inscription	RDESIGN
Soft leather comfort seats	o	•	o
Charcoal leather upholstery (R-Design)	n/a	n/a	o
Charcoal headliner	o	o	•
Auto dimming inner and outer mirrors (iii)	o	o	o
Power driver seat with memory function	o	•	•
Power passenger seat (ii)	o	•	•
Mechanical cushion extension driver and passenger seat	o	•	•
Heated steering wheel	o	o	o
Heated windscreen	o	o	o
Heated front seats	o	o	o
Heated rear seats (i)	o	o	o
Power folding rear headrests	o	o	o
12V power outlet in cargo area	o	o	o
Grocery bag holder - luggage area	o	o	o
Interior illumination - high level	o	•	•
Premium Sound by Harman / Kardon	o	o	o
Smartphone integration (Apple CarPlay and Android Auto)	o	•	•
Inductive charging for smartphones, front tunnel console	o	•	•
Power operated tailgate	o	o	o
Power child locks - rear side doors	o	o	o
Load protection net - backrest	o	o	o
Orange lava interior floor carpets (R-Design)	n/a	n/a	o

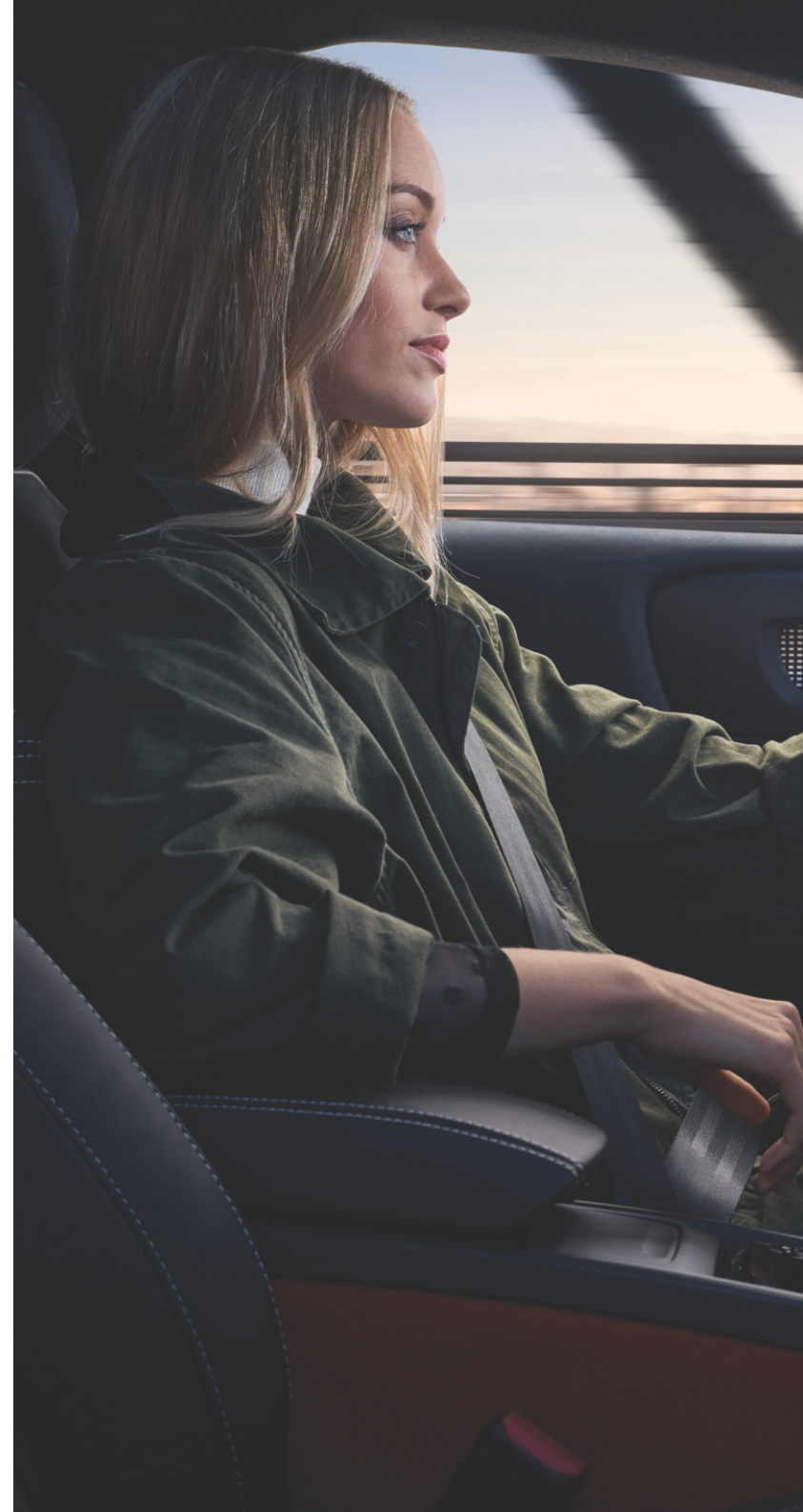



*** OPTIONAL EQUIPMENT – EXTERIOR**

	Momentum	Inscription	R-DESIGN
Power panoramic sunroof	o	o	o
LED headlights with active bending and headlight cleaning - high level	o	o	o
Fog lights in front spoiler	o	●	●
Heated windscreen washer nozzles	o	o	o
19" 5-Spoke black diamond cut alloy wheels (Momentum only)	o	n/a	n/a
19" 5-Double spoke black diamond cut alloy wheels (Inscription only)	n/a	o	n/a
19" 5-Spoke black / white alloy wheels (Momentum only)	o	n/a	n/a
20" 5-Spoke black diamond cut alloy wheels	o	o	n/a
20" 5-Double-spoke matt black diamond cut alloy wheels (R-Design)	n/a	n/a	o
21" 5-Triple open spoke black diamond cut alloy wheels	o	o	n/a
Sports chassis	o	o	●
Four-C chassis (Continuously Controlled Chassis Concept)	o	o	o
Solid white exterior roof colour (Momentum only)	o	n/a	n/a
White exterior mirror caps (iv)	o	n/a	n/a
Metallic paint	o	o	o



● = standard; o = option; n/a = not available * Fitted at factory

- (i) Only in combination with heated front seats.
- (ii) Only in combination with power driver seat.
- (iii) Only in combination with BLIS.
- (iv) Only in combination with 19" 5-spoke black / white alloy wheels.

	Momentum	Inscription	RDESIGN
XC40 SPORT PACK			
Heated front seats	o		
LED front fog lights	o		
Power driver seat with memory function	o		
Headlight washers	o		
Power operated tailgate	o		
Grocery bag holder - luggage area	o		
12V power outlet in cargo area	o		
LED headlights with active bending lights - high level	o		
Park assist, front and rear	o		
Rear parking camera	o		
Interior lighting - high version	o		
20" 5-Spoke black diamond cut alloy wheels (swop for 18", 19" or 21" wheels)	o		
XC40 SPORT PACK			
Heated front seats		o	
Headlight washers		o	
Power operated tailgate		o	
Grocery bag holder - luggage area		o	
12V power outlet in cargo area		o	
Power folding rear headrests		o	
LED headlights with active bending lights - High level		o	
Park assist, front and rear		o	
Rear parking camera		o	
19" 5-Double spoke black diamond cut alloy wheels (swop for 18", 19" or 21" wheels)		o	
XC40 SPORT PACK - WHITE			
Heated front seats	o		
LED front fog lights	o		
Power driver seat with memory function	o		
Headlight washers	o		
Power operated tailgate	o		
Grocery bag holder - luggage area	o		
12V power outlet in cargo area	o		
Solid white (614) exterior roof colour	o		
LED headlights with active bending lights - high level	o		
Park assist, front and rear	o		
Rear parking camera	o		
Interior lighting - high version	o		
19" 5-spoke black / white alloy wheels	o		
White exterior mirror caps	o		
XC40 TECHNO PACK			
Heated front seats	o		
LED front fog lights	o		
Power driver seat with memory function	o		
Headlight washers	o		
Power operated tailgate	o		
Grocery bag holder - luggage area	o		
12V power outlet in cargo area	o		
LED headlights with active bending lights - high level	o		
Rear parking camera	o		
Park Assist front and rear	o		
Interior lighting - high version	o		
Smartphone integration	o		
20" 5-Spoke black diamond cut alloy wheels (swop for 18", 19" or 21" wheels)	o		
Inductive charging for smartphone, front tunnel	o		

	Momentum	Inscription	RDESIGN
XC40 TECHNO PACK			
Heated front seats		o	
Headlight washers		o	
Power operated tailgate		o	
Grocery bag holder - luggage area		o	
12V power outlet in cargo area		o	
Power folding rear headrests		o	
LED headlights with active bending lights - high level		o	
Rear parking camera		o	
Park Assist front and rear		o	
19" 5-Double spoke black diamond cut alloy wheels (swop for 18", 19" or 21" wheels)		o	
XC40 TECHNO PACK - WHITE			
Heated front seats	o		
LED front fog lights	o		
Power driver seat with memory function	o		
Headlight washers	o		
Power operated tailgate	o		
Grocery bag holder - luggage area	o		
12V power outlet in cargo area	o		
Solid white (614) exterior roof colour	o		
LED headlights with active bending lights - high level	o		
Rear parking camera	o		
Park Assist front and rear	o		
Interior lighting - high version	o		
Smartphone integration	o		
Inductive charging for smartphone, front tunnel	o		
19" 5-Spoke black / white alloy wheels	o		
White exterior mirror caps	o		
XC40 PREMIUM PACK			
Heated front seats	o		
LED front fog lights	o		
Power driver seat with memory function	o		
Headlight washers	o		
Power operated tailgate	o		
Grocery bag holder - luggage area	o		
12V power outlet in cargo area	o		
LED headlights with active bending lights - high level	o		
Rear parking camera	o		
Park Assist front and rear	o		
Interior lighting - high version	o		
Smartphone integration	o		
20" 5-Spoke black diamond cut alloy wheels (swop for 18", 19" or 21" wheels)	o		
Inductive charging for smartphone, front tunnel	o		
Harman / Kardon Premium Sound system	o		
XC40 PREMIUM PACK			
Heated front seats		o	
Headlight washers		o	
Power operated tailgate		o	
Grocery bag holder - luggage area		o	
12V power outlet in cargo area		o	
Power folding rear headrests		o	
LED headlights with active bending lights - high level		o	
Rear parking camera		o	
Park Assist front and rear		o	
19" 5-Double spoke black diamond cut alloy wheels (swop for 18", 19" or 21" wheels)		o	
Harman / Kardon Premium Sound system		o	

	Momentum	Inscription	
XC40 PREMIUM PACK - WHITE			
Heated front seats	o		
LED front fog lights	o		
Power driver seat with memory function	o		
Headlight washers	o		
Power operated tailgate	o		
Grocery bag holder - luggage area	o		
12V power outlet in cargo area	o		
Solid white (614) exterior roof colour	o		
LED headlights with active bending lights - high level	o		
Rear parking camera	o		
Park Assist front and rear	o		
Interior lighting - high version	o		
Smartphone integration	o		
19" 5-Spoke black / white alloy wheels	o		
Inductive charging for smartphone, front tunnel	o		
Harman / Kardon Premium Sound system	o		
White exterior mirror caps	o		
XC40 PREMIUM SUPPORT PACK			
Heated front seats	o		
LED front fog lights	o		
Power driver seat with memory function	o		
Headlight washers	o		
Power operated tailgate	o		
Grocery bag holder - luggage area	o		
12V power outlet in cargo area	o		
IntelliSafe Assist with Adaptive Cruise Control and Pilot Assist	o		
360° camera	o		
Automatically dimmed interior and exterior mirrors	o		
Blind Spot Information System with Cross Traffic Alert	o		
LED headlights with active bending lights - high level	o		
Park Assist Pilot and park assist, front and rear	o		
Interior lighting - high version	o		
Smartphone integration	o		
20" 5-Spoke black diamond cut alloy wheels (swop for 18", 19" or 21" wheels)	o		
Inductive charging for smartphone, front tunnel	o		
Harman / Kardon Premium Sound system	o		
XC40 PREMIUM SUPPORT PACK			
Heated front seats		o	
Headlight washers		o	
Power operated tailgate		o	
Grocery bag holder - luggage area		o	
IntelliSafe Assist with Adaptive Cruise Control and Pilot Assist		o	
360° camera		o	
Automatically dimmed interior and exterior mirrors		o	
12V power outlet in cargo area		o	
Power folding rear headrests		o	
Blind Spot Information System with Cross Traffic Alert		o	
LED headlights with active bending lights - high level		o	
Park Assist Pilot and park assist, front and rear		o	
19" 5-Double spoke black diamond cut alloy wheels (swop for 18", 19" or 21" wheels)		o	
Harman / Kardon Premium Sound system		o	

	Momentum	Inscription	
XC40 PREMIUM SUPPORT PACK - WHITE			
Heated front seats	o		
LED front fog lights	o		
Power driver seat with memory function	o		
Headlight washers	o		
Power operated tailgate	o		
Grocery bag holder - luggage area	o		
12V power outlet in cargo area	o		
IntelliSafe Assist with Adaptive Cruise Control and Pilot Assist	o		
360° camera	o		
Solid white (614) exterior roof colour	o		
Automatically dimmed interior and exterior mirrors	o		
Blind Spot Information System with Cross Traffic Alert	o		
LED headlights with active bending lights - high level	o		
Park Assist Pilot and park assist, front and rear	o		
Interior lighting - high version	o		
Smartphone integration	o		
Inductive charging for smartphone, front tunnel	o		
19" 5-Spoke black / white alloy wheels	o		
Harman / Kardon Premium Sound system	o		
White exterior mirror caps	o		
XC40  PACK			
Heated front seats			o
Headlight washers			o
Power operated tailgate			o
Grocery bag holder - luggage area			o
12V power outlet in cargo area			o
Power folding rear headrests			o
LED headlights with active bending lights - high level			o
Rear parking camera			o
Park Assist front and rear			o
20" 5-Double spoke matt black diamond cut alloy wheels (swop for 19" wheels)			o
Harman / Kardon Premium Sound system			o
XC40  SUPPORT PACK			
Heated front seats			o
Headlight washers			o
Power operated tailgate			o
Grocery bag holder - luggage area			o
IntelliSafe Assist with Adaptive Cruise Control and Pilot Assist			o
360° camera			o
Automatically dimmed interior and exterior mirrors			o
12V power outlet in cargo area			o
Power folding rear headrests			o
Blind Spot Information System with Cross Traffic Alert			o
LED headlights with active bending lights - high level			o
Park Assist Pilot and park assist, front and rear			o
20" 5-Double spoke matt black diamond cut alloy wheels (swop for 19" wheels)			o
Harman / Kardon Premium Sound system			o
XC40 DRIVER SUPPORT PACK			
IntelliSafe Assist with Adaptive Cruise Control and Pilot Assist	o	o	o
Automatically dimmed interior and exterior mirrors	o	o	o
Blind Spot Information System with Cross Traffic Alert	o	o	o

o = option; n/a = not available



POLESTAR POLESTAR ENGINEERED OPTIMIZATIONS.

Polestar engineers have taken a holistic approach to form a complete software solution that takes your driving to a new level. Five key functions have been optimized to provide faster response, better balance and more intuitive driving. This results in a car that responds quickly and predictably, which is important for those who engage in active driving, whether on the racetrack or on the road. This software upgrade is available through your local Retailer upon request.

Throttle Response

Throttle response has been recalibrated to provide improved feedback and accelerator reaction – ideal for overtaking or during active driving on a winding road.

Off Throttle Response

The engine and transmission have been calibrated to provide faster responses when the driver suddenly releases the throttle, providing improved predictability and control.

Gearshift Speed

Shift speed has been increased, allowing the car to accelerate faster and react more directly to driver input.

Gearshift Precision and Gear Hold

Shift points have been optimized to provide a more precise driving experience with faster acceleration. Gearshift points have been calibrated to utilize the optimized mid-range engine performance, while the gear hold function maintains the same gear when cornering with high lateral g-force.

Engine Performance

All Drive-E optimizations are made to provide greater performance in the engine's mid-range powerband – perfect for the sporty driver when overtaking, joining a highway or exiting a corner.

Engine	Transmission	Model Year	Original	Polestar	Difference
D4 Drive-E	8-Speed Geartronic	2020	140kW / 400Nm	147kW / 440Nm	+7kW / +40Nm
T5 Drive-E	8-Speed Geartronic	2020	185kW / 350Nm	188kW / 400Nm	+3kW / +50Nm





IN FINE DETAIL. The nuts and bolts of your Volvo XC40. Whatever you need to know about your new car – be it fuel consumption, CO₂ emissions, top speed or boot space – you will find it here.

ENGINE	T3 Manual FWD	T3 Geartronic FWD	D4 Geartronic AWD	T5 Geartronic AWD
Configuration	Transverse – 12 valve	Transverse – 12 valve	Transverse – 16 valve	Transverse – 16 valve
Cylinders	3	3	4	4
Engine capacity, cc	1477	1477	1969	1969
Bore x stroke, mm	82 x 93.2	82 x 93.2	82 x 93.2	82 x 93.2
Max. output ECE, kW rpm	120 5500	110 5500	140 4000	185 5500
Max. torque ECE, Nm rpm	265 1850-3000	265 1500-3000	400 1750-2500	350 1800-4800
Octane rating	95 RON unleaded	95 RON unleaded	50ppm Diesel	95 RON unleaded
Fuel system	HP Turbocharger	HP Turbocharger	Twin Turbochargers	HP Turbocharger
Compression ratio	10,5:1	10,5:1	15,8:1	10,8:1

PERFORMANCE	T3 Manual FWD	T3 Geartronic FWD	D4 Geartronic AWD	T5 Geartronic AWD
Top speed, km/h	200	195	210	230
Acceleration 0-100 km/h, sec	9.3	10.1	7.9	6.4

FUEL CONSUMPTION*	T3 Manual FWD	T3 Geartronic FWD	D4 Geartronic AWD	T5 Geartronic AWD
Combined, l/100 km*	6.3	6.7	5.0	7.7
CO ₂ , g/km*	142	154	131	164
Fuel tank capacity, litres	54	54	54	54

The results do not express or imply any guarantee of the fuel consumption of a particular car as there are inevitable differences between individual cars of the same model.

Additionally, driving style, traffic conditions, as well as the age and mileage and standard of maintenance will affect a car's fuel consumption.

- * All fuel consumption figures and CO₂ emissions are based on the New European Driving Cycle (NEDC) test procedure. This test procedure is designed to assess the emission levels of car engines and fuel economy in passenger cars.
- * The results do not express or imply any guarantee of the fuel consumption of a particular car as there are inevitable differences between individual cars of the same model. Additionally, driving style, traffic conditions, as well as the age and mileage and standard of maintenance will affect a car's fuel consumption.
- * The weight of the vehicle will influence the level of CO₂ emitted. As a result, vehicles with higher levels of specification and factory fit options may emit higher levels of CO₂.

TURNING CIRCLE	ALL MODELS
18" wheels	11.4 m
19" wheels	11.8 m

LUGGAGE COMPARTMENT	ALL MODELS
Volume, litres	460
Under floor volume, litres	73
Volume, largest litres	1336

TRANSMISSION	ALL MODELS
Manual FWD	6-speed
Geartronic FWD	8-speed
Geartronic AWD	8-speed

BRAKES	ALL MODELS
Front disc diameter, mm	322
Rear disc diameter, mm	302

GROUND CLEARANCE	ALL MODELS
Vehicle ground clearance, mm	211

WEIGHT	T3 Manual FWD	T3 Geartronic FWD	D4 Geartronic AWD	T5 Geartronic AWD
Min. kerb weight, kg (actual kerb weight dependent on spec.)	1503	1554	1698	1714
Max. possible towing weight braked, kg	1600	1600	2100	2100
Max. towing weight unbraked, kg**	750	750	750	750
Max. towball weight, kg	110	110	110	110
Max. total weight, kg	2060	2120	2250	2220
Max. roof load, kg	75	75	75	75
Max. payload, kg (dependent on spec.)	557	566	552	506

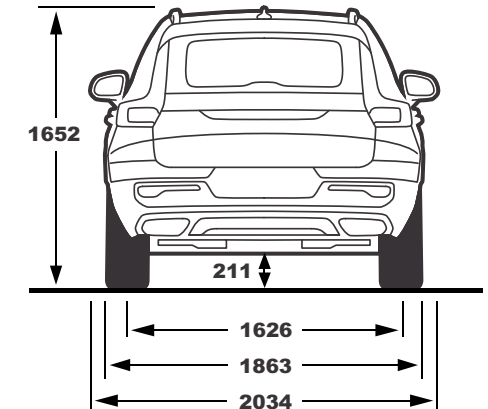
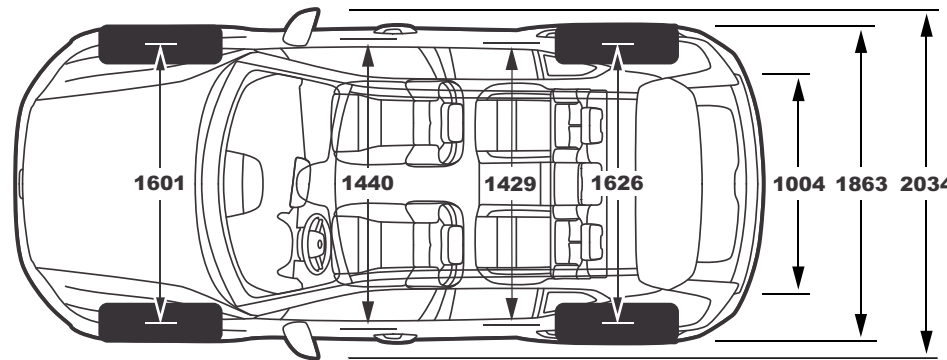
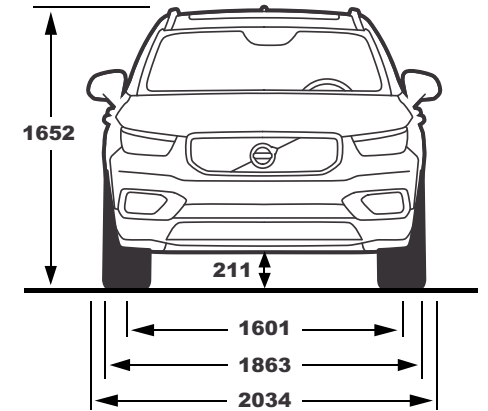
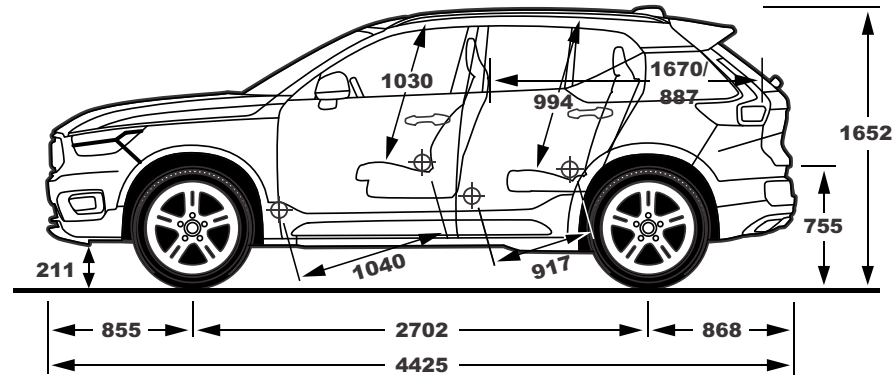

All measurements in mm.

** Unbraked towing weight must not exceed 50% of kerb weight up to a maximum of approximately 750 kg.

NB Some of the information in this brochure may not be correct due to product changes which may have occurred since it was printed. Some of the equipment described or shown may now be available only at extra cost. Before ordering, please ask your Volvo dealer for the latest information. The manufacturer reserves the right to make changes at any time, without notice, to colour, materials, specifications and models.

Volvo Car South Africa.



Volvo Car Finance
A product of WesBank

Volvo Car Financial Services

Volvo Car Financial Services has flexible financing options that enable you to structure your deal according to your specific requirements.

We want your experience of buying and owning a Volvo to be enjoyable and hassle-free. That is why we have developed the following online service tools:

- Online finance application – apply for finance any time of day or night and get an instant answer.
- Calculators – calculate your monthly repayments or calculate the value of a vehicle that you could buy based on a specified monthly repayment.
- Account services – manage your account in a secure and user-friendly online environment in real time.

So, remember to insist on Volvo Car Financial Services at your dealer or simply visit www.volvocars.com/za for more information.



Volvo Car Finance
A product of WesBank

Volvo Versatility Finance

For a tailor-made deal and guaranteed future value.

With best-in-class guaranteed future value across the entire Volvo range, it is a forward-thinking way to finance and future-proof your dream Volvo. When you reach the end of your finance period, you can renew, return or retain your Volvo. It is all up to you.

Flexibility today. Certainty tomorrow.

* Terms and conditions apply. As at time of print.

My Volvo App

The official Volvo Car South Africa App that lets you connect with your integrated services.

Integrated services include:

- Volvo Car Finance – Information around your finance agreement with Volvo Car Finance.
- My Volvo – Details around your specific vehicle.
- Tracker info – Tracker information like emergency assist, roadside assist, current location, and odometer adjustment.
- Volvo Insurance – Ability to arrange insurance for your vehicle.
- Warranties – Request a quote for warranty extensions.
- News – Current news around the Volvo Car family.
- Volvo Rental – Apply for your Volvo Rental.



Car Insurance

Volvo Car Insurance

Peace of mind. Our idea of luxury.

A Volvo-personalised insurance scheme. Highly competitive comprehensive insurance premiums available on all Volvo models.

Ask your Volvo dealer for more information.

Underwritten by Guardrisk Insurance Company (PTY) LTD, FSP NO:75.
Administered by Insurance Underwriting Managers (PTY) LTD, FSP NO:21820.

* Terms and conditions apply.

Volvo On Call (VOC)

One app gives you control over your car's functions and access to a world of convenience. Providing you with the best personal motoring services in the country. Your Volvo now comes standard with VOC*. Pleaser refer to page 12 for more information.

Should your personal details change or you need to update your information, please contact **0800 MY VOLVO (0800 698 6586)**.

* Model year dependant.

V O L V O

All models standard with a 5 year / 100 000km Volvo Plan.

NB Some of the information in this brochure may not be correct due to product changes which may have occurred since it was printed. Before ordering, please ask your Volvo dealer for the latest information. The manufacturer reserves the right to make changes at any time, without notice, to colour, materials, specifications and models. Issued June 2019.

VOLVOCARS.COM/ZA